

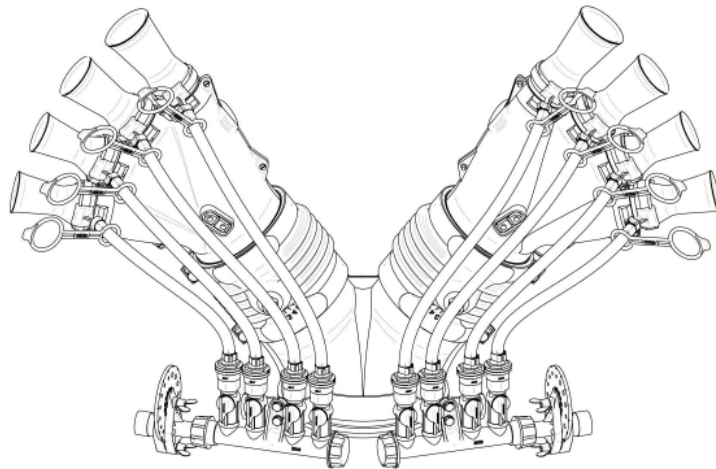

VENTURI AIR SPRAYERS VINEYARD HEAD



**Parts Manual For
T4+44512 Vineyard Head - 8 Nozzle
For P45 Sprayers**

May 2013

TABLE OF CONTENTS

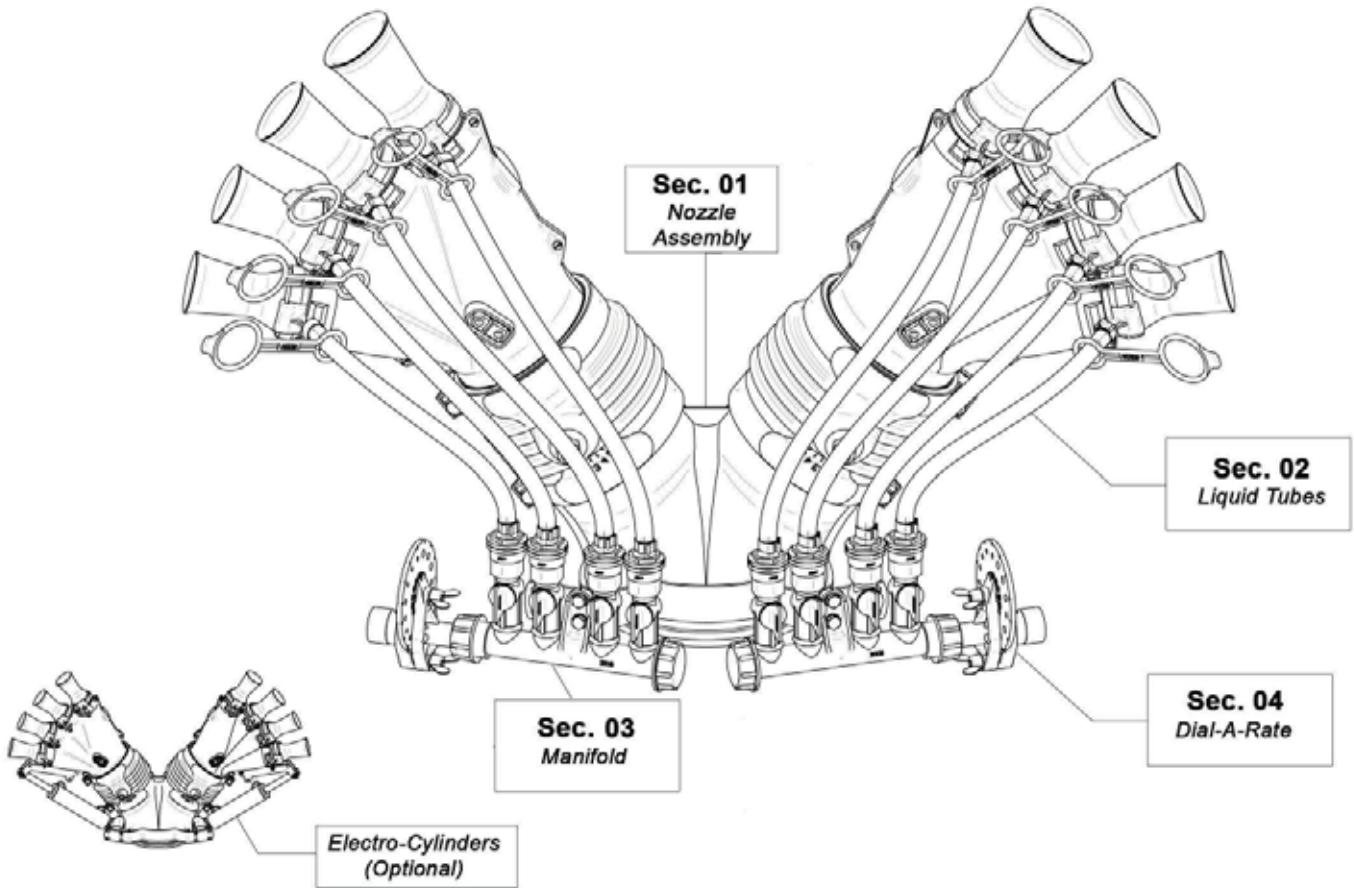

<u>SECTION</u>	<u>DESCRIPTION</u>	<u>PAGE</u>
1	Nozzle Parts	1
2	Liquid Parts - Right Hand.....	2
	Liquid Parts - Left Hand	3
3	Manifold & Shut-Off Valves.....	4
4	Dial-A-Rate	5

Sec. 01 - NOZZLE PARTS

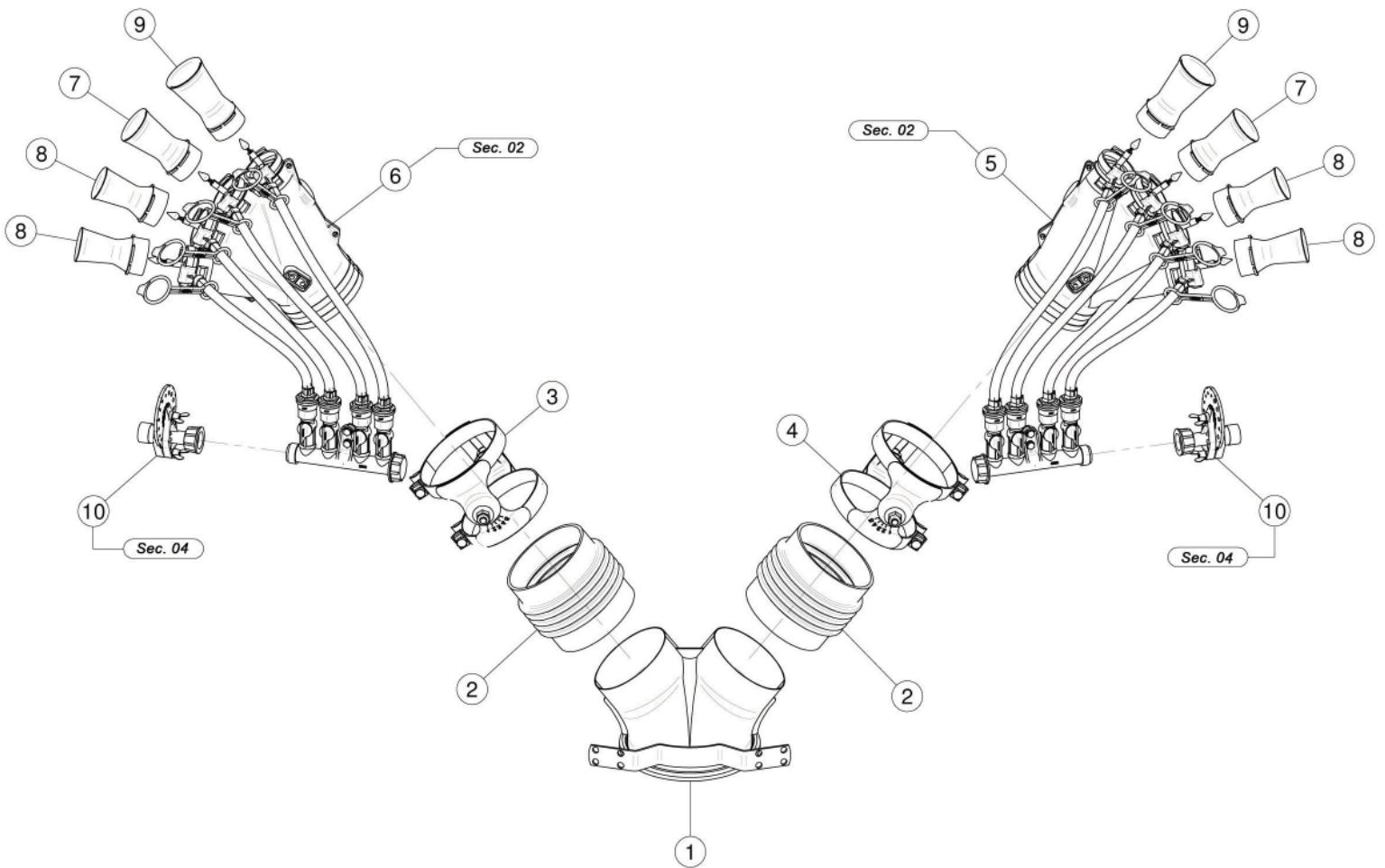

<u>REF.</u>	<u>QTY.</u>	<u>PART NO.</u>	<u>DESCRIPTION</u>
1	1	02.739.000	Body Head
2	2	02.021.000	Flexible Sleeve
3	1	21.081.000	Left Clamp Ø127
4	1	21.080.000	Right Clamp Ø127
5	1	20.014.04CSX	4 Outlets With Distributor
6	1	20.014.04CDX	4 Outlets With Distributor
7	2	00.008.050	Nozzle 8/50
8	4	00.006.050	Nozzle 6/50
9	2	00.010.050	Nozzle 10/50
10	2	02.150.000	Rotation Disc Regulation

Sec. 02 - LIQUID PARTS - RIGHT HAND

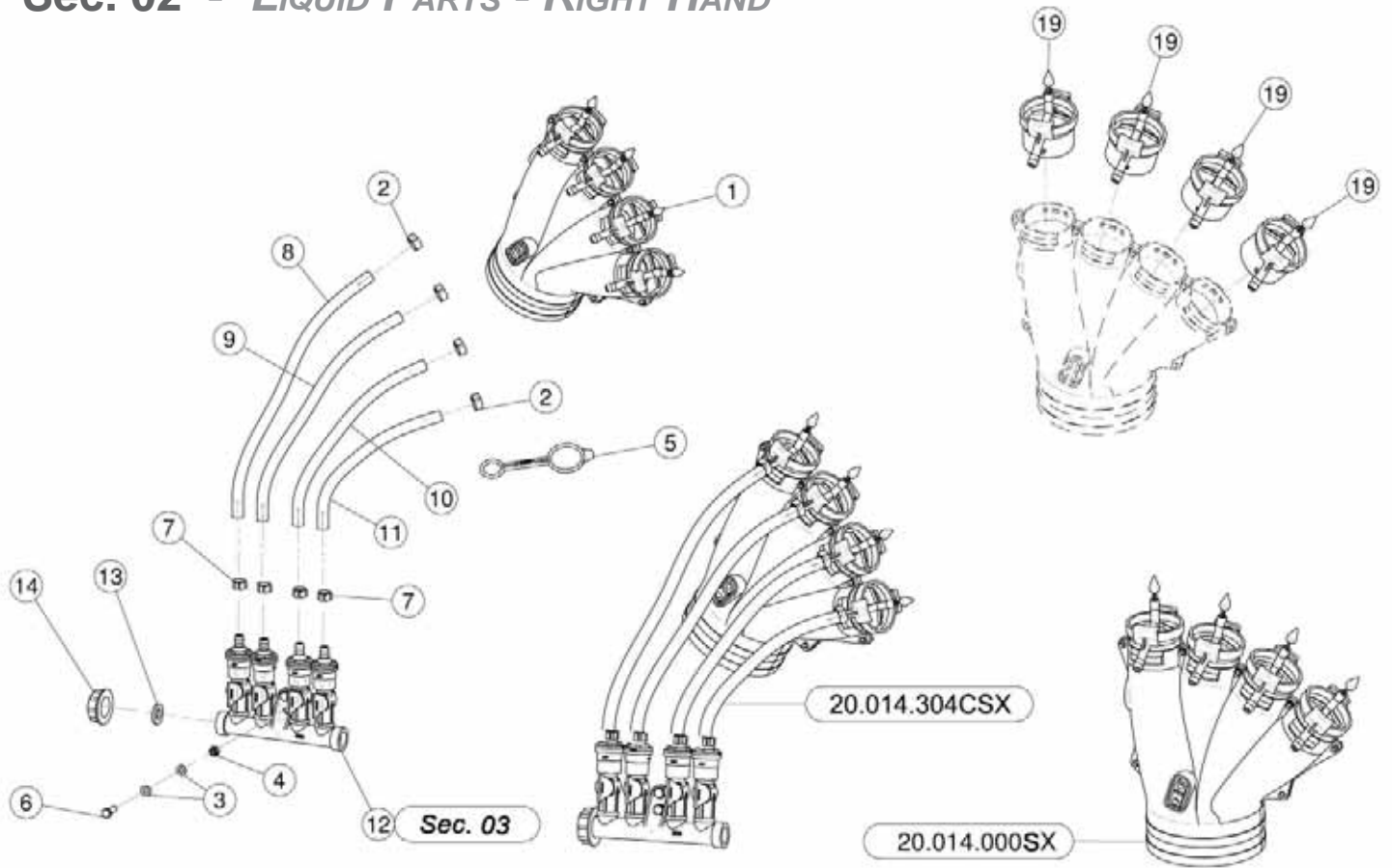

<u>REF.</u>	<u>QTY.</u>	<u>PART NO.</u>	<u>DESCRIPTION</u>
20.014.304CSX			
1	1	20.014.000SX	Four Outlets R.H.
2	4	FC.012.5.014	Hose Clamp
3	4	RP.006.000	Washer D.6
4	2	D0.06.5588G	Nut M6
5	4	20.697.000	Nozzle Stop
6	2	TE.006.020T	Screw TE M6 x 20
7	4	FC.013.5.015	Hose Clamp
8	1	02.217.034	Hose D.8 x 13 L=340
9	1	02.217.033	Hose D.8 x 13 L=330
10	1	02.217.028	Hose D.8 x 13 L=280
11	1	02.217.024	Hose D.8 x 13 L=240
12	1	02.008.304C	4 Taps Liquid Manifold
13	1	02.030.010	Gasket
14	1	02.182.000	Female 3/4" Cap
20.014.000SX			
19	4	20.016.01C	Tube With Liquid Outlet

Sec. 02 - LIQUID PARTS - LEFT HAND

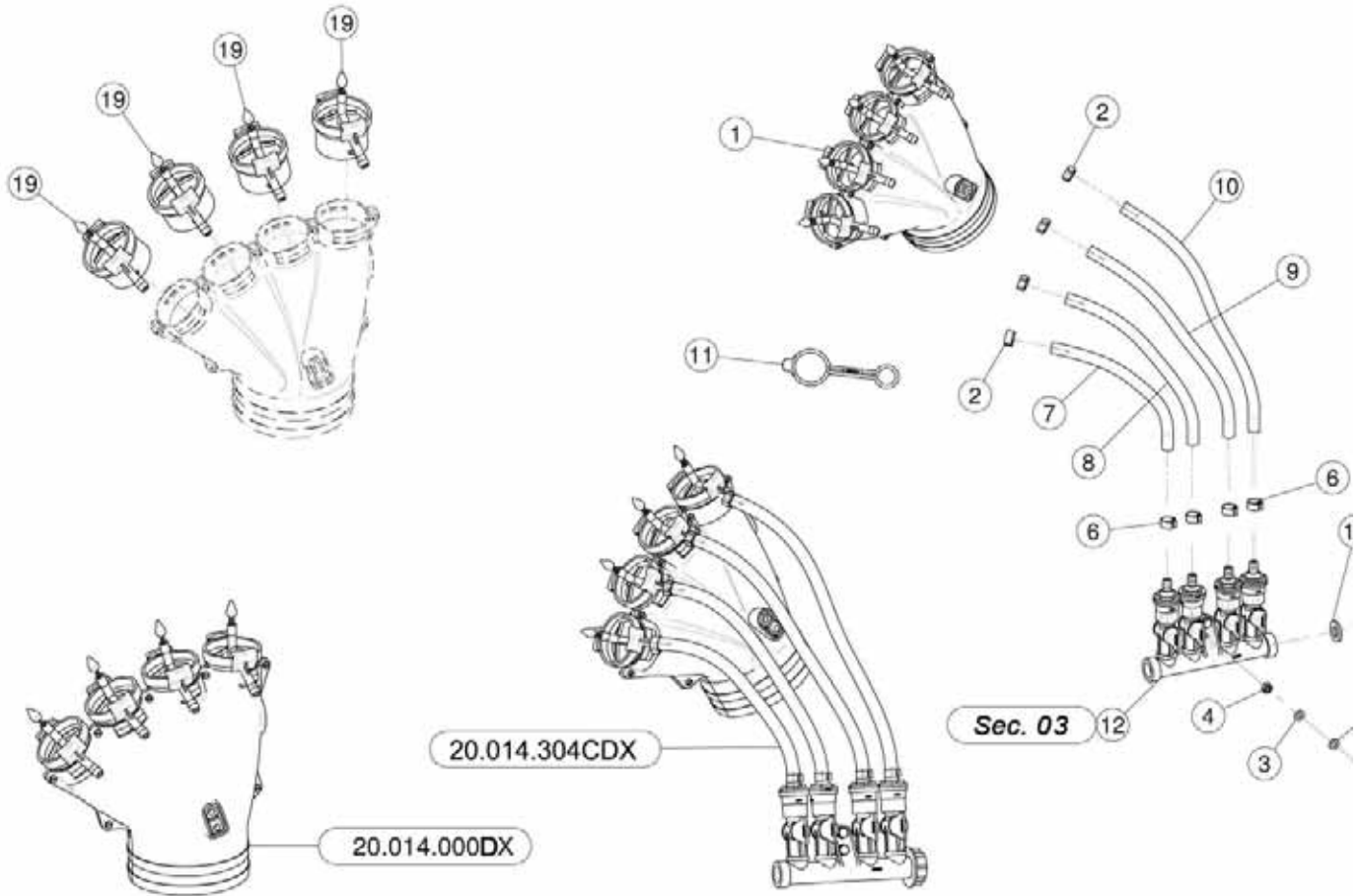

<u>REF.</u>	<u>QTY.</u>	<u>PART NO.</u>	<u>DESCRIPTION</u>
20.014.304CDX			
1	1	20.014.000DX	Four Outlets L.H.
2	4	FC.012.5.014	Hose Clamp
3	4	RP.006.000	Washer D.6
4	2	D0.06.5588G	Nut M6
5	2	TE.006.020T	Screw TE M6 x 20
6	4	FC.013.5.015	Hose Clamp
7	1	02.217.024	Hose D.8 x 13 L=240
8	1	02.217.028	Hose D.8 x 13 L=280
9	1	02.217.033	Hose D.8 x 13 L=330
10	1	02.217.034	Hose D.8 x 13 L=340
11	4	20.697.000	Nozzle Stop
12	1	02.008.304C	4 Taps Liquid Manifold
13	1	02.182.000	Female 3/4" Cap
14	1	02.030.010	Gasket
20.014.000DX			
19	4	20.016.01C	Tube With Liquid Outlet

Sec. 03 - MANIFOLD & SHUT-OFF VALVES

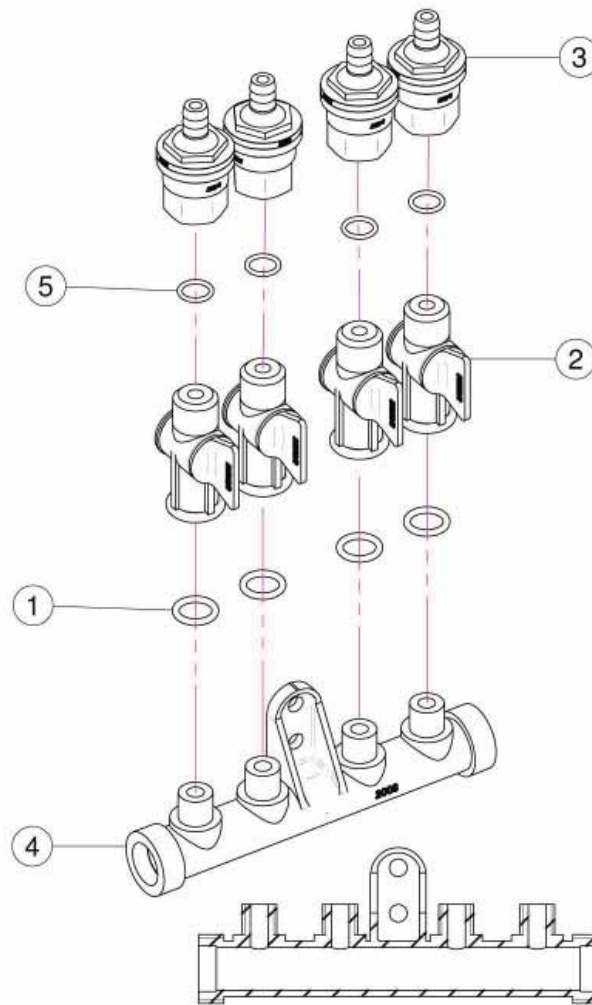

<u>REF.</u>	<u>QTY.</u>	<u>PART NO.</u>	<u>DESCRIPTION</u>
		02.008.304C	Complete Assembly
1	4	OR.000.117	13.1 x 18.34 x 2.62 O-Ring Gasket
2	4	20.202.100	Tap Assembly
3	4	00.227.01C	Anti-Drip Valve
4	1	02.008.000	Sprayheads Liquid Manifold
5	4	OR.002.043	10.82 x 14.38 x 1.78 Nbr 70 O-Ring Gasket

Sec. 04 - DIAL-A-RATE

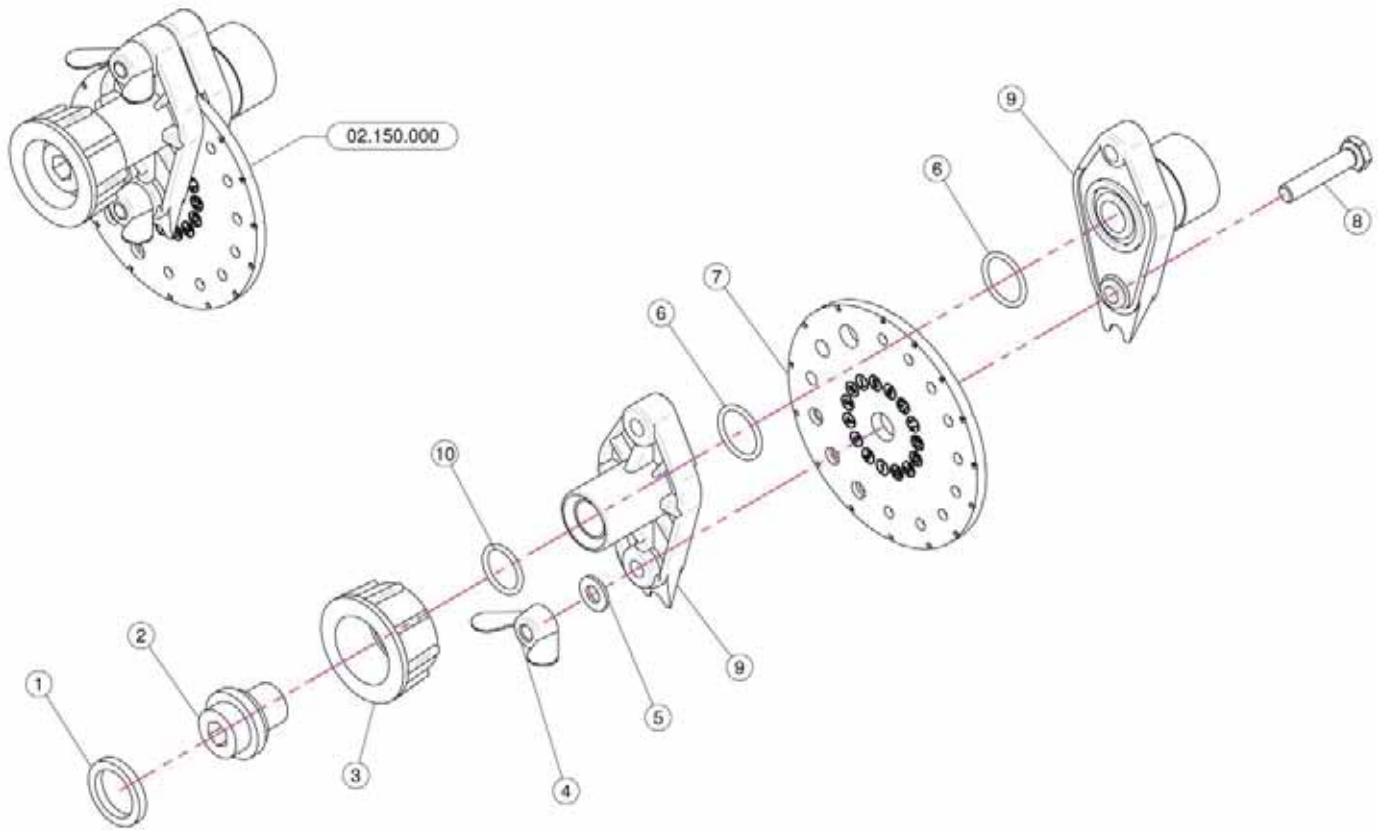

<u>REF.</u>	<u>QTY.</u>	<u>PART NO.</u>	<u>DESCRIPTION</u>
1	1	02.349.000	17 x 23 x 3 Flat Gasket
2	1	02.117.000	Adaptor Nipple
3	1	2002030	3/4" Fly Nut
4	2	DF.OTT.006	Wing Nut M6
5	2	RP.006.000I	INOX Washer D.6
6	2	OR1560178	D.15.6 x 1.78 O-Ring
7	1	02.148.000	Regulator Disc
8	2	TE.006.030I	INOX M6 x 30 Bolt
9	1	02.147.000	Regulator Body
10	1	OR1242178	O-Ring D.12.37 x 2.62