

GEARMORE INC.

SLICING AERATORS

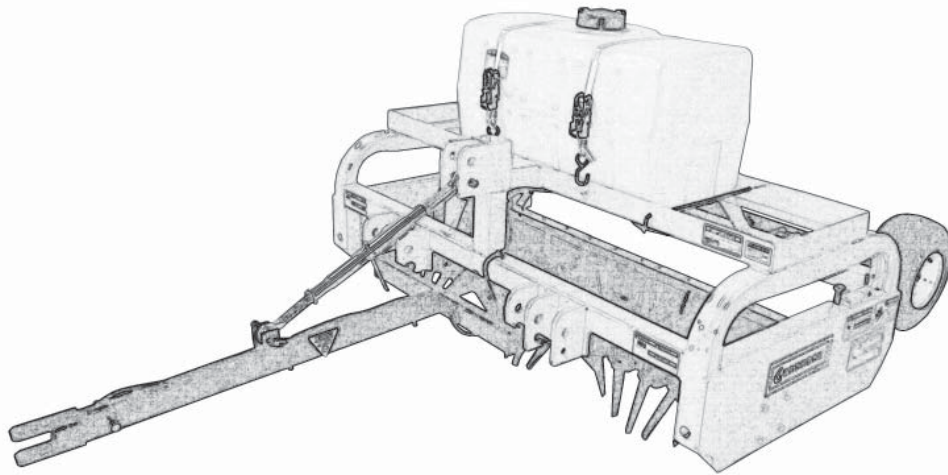

**Assembly/Operator's
& Parts Manual
For SP Series
48", 60", & 72"**

March 2010

TABLE OF CONTENTS

SECTION	DESCRIPTION	PAGE
1	Introduction	1
1.1	Serial Number Location	1
2	Safety.....	2
2.1	General Safety	3
2.2	Equipment Safety Guidelines	4
2.3	Safety Training	5
2.4	Safety Signs	5
2.5	Preparation	6
2.6	Operating Safety	7
2.7	Transport Safety	8
2.8	Storage Safety	8
2.9	Maintenance Safety	8
3	Safety Sign Decals.....	9 - 10
4	Operation	10
4.1	To the New Operator or Owner	10
4.2	Machine Break-In	11
4.3	Pre-Operation Checklist.....	11
4.4	Field Operation	12
4.5	Transporting	13
4.6	Storage	13
5	General Maintenance	14
5.1	Tines	14
5.2	Tines Replacement	14
5.3	Bearing Maintenance	14
5.4	Torque Specifications.....	15
6	Replacement Parts.....	16
6.1	Bearings & Tines	16
6.2	Miscellaneous Parts.....	17
6.3	Frame & Brush Assembly	18
6.4	Replacement Axle	19
6.5	Replacement Parts.....	20 - 21
7	Limited Warranty.....	22

1 INTRODUCTION

Congratulations on your choice of a Gearmore Slicing Aerator. This equipment has been designed and manufactured to meet the needs of a discriminating buyer for the efficient aeration of land.

Safe, efficient and trouble free operation of your Aerator requires that you and anyone else who will be operating or maintaining the machine, read and understand the Safety, Operation, Maintenance and Troubleshooting information contained within the Operator's Manual.

This manual covers the SP Series of slicing aerators. Use the Table of Contents as a guide to locate required information.

Keep this manual handy for frequent reference and to pass on to new operators or owners. Call your Gearmore dealer or distributor if you need assistance, information or additional copies of the manuals.

OPERATOR ORIENTATION - The directions left, right, front and rear, as mentioned throughout this manual, are as seen from the driver's seat and facing in the direction of travel.

1.1 SERIAL NUMBER LOCATION

Always give your dealer the serial number of your Aerator when ordering parts or requesting service or other information.

The serial number plate is located where indicated. Please mark the number in the space provided for easy reference.

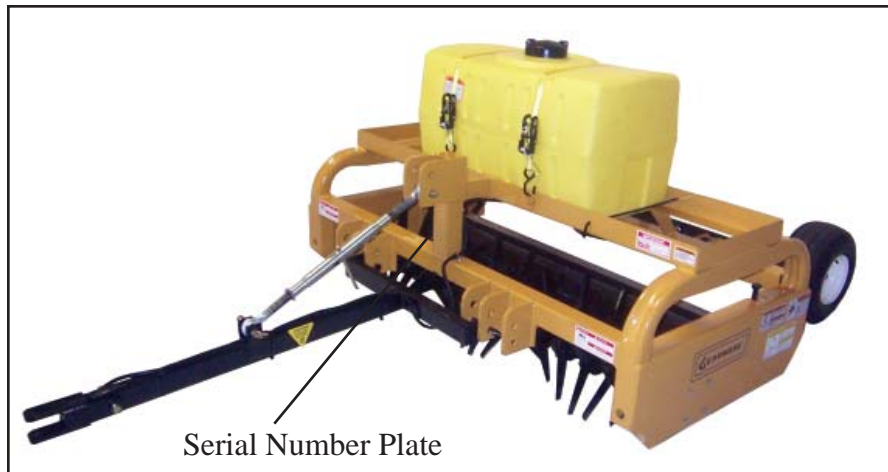

DATE OF PURCHASE: _____

MODEL NUMBER: _____

SERIAL NUMBER: _____

2 SAFETY

SAFETY ALERT SYMBOL

This Safety Alert symbol means **ATTENTION! BECOME ALERT! YOUR SAFETY IS INVOLVED!**



The Safety Alert symbol identifies important safety messages on the Aerator and in the manual. When you see this symbol, be alert to the possibility of personal injury or death. Follow the instructions in the safety message.

Why is SAFETY important to you?

3 Big Reasons

Accidents Disable and Kill
Accidents Cost
Accidents Can Be Avoided

SIGNAL WORDS:

Note the use of the signal words **DANGER**, **WARNING** and **CAUTION** with the safety messages. The appropriate signal word for each message has been selected using the following guide-lines:

SI NO LEE INGLES, PIDA AYUDA A AIGUIEN QUE SI LO LEA PARA QUE LE TRADUZCA LAS MIDIDAS DE SEGURIDAD.

DANGER - Indicates an imminently hazardous situation that, if not avoided, will result in death or serious injury. This signal word is to be limited to the most extreme situations typically for machine components which, for functional purposes, cannot be guarded.

WARNING - Indicates a potentially hazardous situation that, if not avoided, could result in death or serious injury, and includes hazards that are exposed when guards are removed. It may also be used to alert against unsafe practices.

CAUTION - Indicates a potentially hazardous situation that, if not avoided, may result in minor or moderate injury. It may also be used to alert against unsafe practices.

If you have any questions not answered in this manual or require additional copies or the manual is damaged, please contact your dealer.

2.1 GENERAL SAFETY

YOU are responsible for the **SAFE** operation and maintenance of your Aerator. **YOU** must ensure that you and anyone else who is going to operate, maintain or work around the Aerator be familiar with the operating and maintenance procedures and related **SAFETY** information contained in this manual. This manual will take you step-by-step through your working day and alerts you to all good safety practices that should be adhered to while operating the Aerator.

Remember, **YOU** are the key to safety. Good safety practices not only protect you, but also the people around you. Make these practices a working part of your safety program. Be certain that **EVERYONE** operating this equipment is familiar with the recommended operating and maintenance procedures and follows all the safety precautions. Most accidents can be prevented. Do not risk injury or death by ignoring good safety practices.

- Aerator owners must give operating instructions to operators or employees before allowing them to operate the machine, and at least annually there after per OSHA (Occupational Safety and Health Administration) regulation 1928.57.
- The most important safety feature on this equipment is a **SAFE** operator. It is the operator's responsibility to read and understand **ALL** Safety and Operating instructions in the manual and to follow these. Most accidents can be avoided.
- A person who has not read and understood all operating and safety instructions is not qualified to operate the machine. An untrained operator exposes himself and bystanders to possible serious injury or death.
- **DO NOT** modify the equipment in any way. Unauthorized modification may impair the function and/or safety and could affect the life of the equipment.
- **Think SAFETY! Work SAFELY!**

1. Read and understand the Operator's Manual and all safety signs before operating, maintaining adjusting or unplugging the Aerator.



2. Have a first-aid kit available for use should the need arise and know how to use it.



3. Have a fire extinguisher available for use should the need arise and know how to use it.



4. Wear appropriate protective gear. This list includes but is not limited to:

- A hard hat
- Protective shoes with slip resistant soles
- Protective goggles, glasses or face shield
- Heavy gloves
- Protective clothing

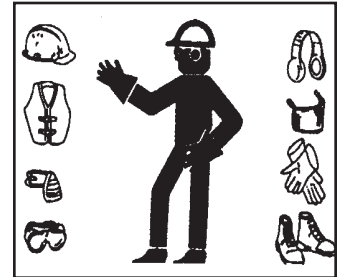

5. Install and secure all guards before starting.

6. **DO NOT** allow riders.

7. Wear suitable ear protection for prolonged exposure to excessive noise.



8. Place all controls in neutral, stop tractor engine, set park brake, remove ignition key and wait for all moving parts to stop before servicing, adjusting, repairing, or unplugging.

9. Clear the area of people, especially small children, before starting.

10. Review safety related items annually with all personnel who will be operating or maintaining the Aerator.

2.2 EQUIPMENT SAFETY GUIDELINES

Safety of the operator and bystanders is one of the main concerns in designing and developing a machine. However, every year many accidents occur which could have been avoided by a few seconds of thought and a more careful approach to handling equipment. You, the operator, can avoid many accidents by observing the following precautions in this section. To avoid personal injury or death, study the following precautions and insist those working with you, or for you, follow them.

- In order to provide a better view, certain photographs or illustrations in this manual may show an assembly with a safety shield removed. However, equipment should **never** be operated in this condition. Keep all shields in place. If shield removal becomes necessary for repairs, replace the shield prior to use.
- Replace any safety sign or instruction sign that is not readable or is missing. Location of such safety signs is indicated in this manual.
- **NEVER** use alcoholic beverages or drugs which can hinder alertness or coordination while operating this equipment. Consult your doctor about operating this machine while taking prescription medications.
- **Under no circumstances should young children be allowed to work with this equipment. Do not allow persons to operate or assemble this unit until they have read this manual and have developed a thorough understanding of the safety precautions and of how it works.** Review the safety instructions with all users annually.

 **WARNING**



Before operating your machine, stop and read this owners manual. Do not attempt to operate the unit until you fully understand the material covered in this manual. Without the knowledge contained in this manual, injury or death can result.

- This equipment is dangerous to children and persons unfamiliar with its operation. The operator should be a responsible, properly trained and physically able person familiar with farm machinery and trained in this equipment's operations. If the elderly are assisting with farm work, their physical limitations need to be recognized and accommodated.
- Use a tractor equipped with a Roll Over Protective Structure (ROPS) and a seat belt.
- **NEVER** exceed the limits of a piece of machinery. If its ability to do a job, or to do so safely, is in question - **DON'T TRY IT.**
- Do not modify the equipment in any way. Unauthorized modification may impair the function and/or safety and could affect the life of the equipment.

In addition to the design and configuration of this implement, including Safety Signs and Safety Equipment, hazard control and accident prevention are dependent upon the awareness, concern, prudence and proper training of personnel involved in the operation, transport, maintenance and storage of the machine. Refer also to Safety Messages and operation instruction in each of the appropriate sections of the tractor and machine manuals. Pay close attention to the Safety Signs affixed to the tractor and the machine.

Think SAFETY! Work SAFELY!



WARNING:

Turning with tines in the ground will cause bearing failure and possible tine damage and thus voids the warranty.

2.3 SAFETY TRAINING

Safety is a primary concern in the design and manufacture of our products. Unfortunately, our efforts to provide safe equipment can be wiped out by a single careless act of an operator or bystander.

In addition to the design and configuration of equipment, hazard control and accident prevention are dependent upon the awareness, concern, prudence and proper training of personnel involved in the operation, transport, maintenance and storage of this equipment.

It has been said, "***The best safety feature is an informed, careful operator.***" We ask you to be that kind of an operator. It is the operator's responsibility to read and understand ALL Safety and Operating instructions in the manual and to follow these. Accidents can be avoided.



Working with unfamiliar equipment can lead to careless injuries. Read this manual, and the manual for your tractor, before assembly or operating, to acquaint yourself with the machines. If this machine is used by any person other than yourself, or is loaned or rented, it is the machine owner's responsibility to make certain that the operator, prior to operating:

- a. Reads and understands the operator's manuals.
- b. Is instructed in safe and proper use.

Should ownership of the equipment be transferred, this manual must also be transferred.

Know your controls and how to stop tractor, engine and machine quickly in an emergency. Read this manual and the one provided with your tractor.

Train all new personnel and review instructions frequently with existing workers. Be certain only a properly trained and physically able person will operate the machinery. A person who has not read and understood all operating and safety instructions is not qualified to operate the machine. An untrained operator exposes himself and bystanders to possible serious injury or death. If the elderly are assisting with farm work, their physical limitations need to be recognized and accommodated.

For any part of this manual that you do not understand, contact your dealer or Gearmore, Inc.

2.4 SAFETY SIGNS

1. Safety decals and this manual must be considered a permanent part of your equipment.
2. Keep safety signs clean and legible at all times.
3. Replace safety signs that are missing or have become illegible.
4. Replaced parts that displayed a safety sign should also display the current sign.
5. Safety signs are available from your authorized dealer or from Gearmore.

How To Install Safety Signs:

- Be sure that the installation area is clean and dry.
- Be sure temperature is above 50° F (10° C).
- Determine exact position before you remove the backing paper. (See Section 3)
- Remove the smallest portion of the split backing paper.
- Align the sign over the specified area and carefully press the small portion with the exposed sticky backing in place.
- Slowly peel back the remaining paper and carefully smooth the remaining portion of the sign in place.
- Small air pockets can be pierced with a pin and smoothed out using the piece of sign backing paper.

2.5 PREPARATION

1. Never operate the tractor and machine until you have read and completely understand this manual, the Tractor Operator's Manual and each of the Safety Messages found on the safety signs on the tractor and machine.

2. Personal protection equipment, including hard hat, safety glasses, safety shoes and gloves are recommended during assembly, installation, operation, adjustment, maintaining, repairing, removal or moving the implement. **DO NOT** allow long hair, loose fitting clothing or jewelry to be around equipment.

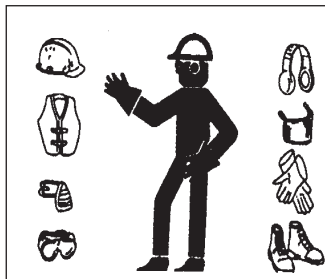

3. **PROLONGED EXPOSURE TO LOUD NOISE MAY CAUSE PERMANENT HEARING LOSS!**

Tractors with or without equipment attached can often be noisy enough to cause permanent, partial hearing loss. We recommend that you wear hearing protection on a full-time basis if the noise in the Operator's position exceeds 80db. Noise over 85db on a long-term basis can cause severe hearing loss. Noise over 90db adjacent to the Operator over a long-term basis may cause permanent, total hearing loss.



NOTE: Hearing loss from loud noise (from tractors, chain saws, radios, and other such sources close to the ear) is cumulative over a lifetime without hope of natural recovery.

4. Operate the machine only with a tractor equipped with an approved Roll-Over Protective Structure (ROPS). Always wear your seat belt. Serious injury or even death could result from falling off the tractor --- particularly during a turn-over when the operator could be pinned under the ROPS or the tractor.
5. Clear working area of stones, branches or hidden obstacles that might be hooked or snagged, causing injury or damage.
6. Operate only in daylight or good artificial light.
7. Be sure machine is properly mounted, adjusted and in good operating condition.
8. Ensure that all safety shielding and safety signs are properly installed and in good condition.



2.6 OPERATING SAFETY

Please remember it is important that you read and heed the safety signs on the Aerator. Clean or replace all safety signs if they cannot be clearly read and understood. They are there for your safety, as well as the safety of others. The safe use of this machine is strictly up to you, the operator.

All things with moving parts are potentially hazardous. There is no substitute for a cautious, safe-minded operator who recognizes potential hazards and follows reasonable safety practices. The manufacturer has designed this Aerator to be used with all its safety equipment properly attached to minimize the chance of accidents. Study this manual to make sure you have all safety equipment attached.

If a safety shield or guard is removed for any reason, it must be replaced before the machine is again operated.

When the use of hand tools is required to perform any part of assembly, installation, adjustment, maintaining, repairing, removal, or moving, be sure the tools used are designed and recommended by the tool manufacturer for that specific task.

Personal protection equipment including hard hat, safety glasses, safety shoes, and gloves are recommended during assembly, installation, operation, adjustment, maintaining, repairing, removal, or moving. Do not allow long hair, loose fitting clothing, or jewelry to be around moving parts.

Always use two people to handle heavy, unwieldy components during assembly, installation, removal, or moving.

Never place any part of your body where it would be in danger if movement should occur during assembly, installation, operation, maintaining, repairing, removal, or moving.

Never place yourself between the tractor and machine while implement is in operation.

Do not walk or work under a raised machine or attachment unless it is securely blocked or held in position. Do not depend on the tractor hydraulic system to hold the machine or attachment in place.

A heavy load can cause instability of the tractor. Use extreme care during travel. Slow down on turns and watch out for bumps. The tractor may need front counterweights to counterbalance the weight of the machine.

Never use alcoholic beverages or drugs, which can hinder alertness or coordination, while operating this equipment. Consult your doctor about operating this machine while taking prescription medications.

Do not allow riders on the machine or tractor at any time. There is no safe place for any riders.

Before you operate the machine, check over all pins, bolts and connections to be sure all are securely in place. Replace any damaged or worn parts immediately.

Do not allow anyone who is not familiar with the safety rules and operation instructions to use this machine.

Never allow children to operate or be around this machine.

Use stabilizer bars, adjustable sway chains, or sway blocks on the tractor lift arms to keep the machine from swinging side to side. Adjust as tightly as practical for best performance.

Clear the work area of objects which might be picked up and snagged or entangled in the machine.

Keep hands, feet, hair, jewelry, and clothing away from all moving and/or rotating parts.

Unauthorized modifications to the equipment are not recommended. This could impair the function, safety, and life of the machine.

2.7 TRANSPORT SAFETY

1. Comply with state and local laws governing highway safety and movement of farm machinery on public roads.
2. The use of flashing amber lights is acceptable in most localities. However, some localities prohibit their use. Local laws should be checked for all highway lighting and marking requirements.
3. At all times, when driving the tractor and equipment on the road or highway under 20 mph (32 kph) use flashing amber warning lights and a slow moving vehicle (SMV) identification emblem. Do not exceed 20 mph (32 kph). Reduce speed on rough roads and surfaces.
4. Plan your route to avoid heavy traffic.
5. Always install transport locks, pins, or brackets before transporting.
6. Do not drink and drive.
7. Be a safe and courteous driver. Always yield to oncoming traffic in all situations, including narrow bridges, intersections, etc. Watch for traffic when operating near or crossing roadways.
8. Turn into curves or go up or down hills only at a low speed and at a gradual steering angle. Make certain that at least 20% of the tractor's weight is on the front wheels to maintain safe steering. Slow down on rough or uneven surfaces.
9. Never allow riders on either tractor or machine.

2.8 STORAGE SAFETY

1. Store the unit in an area away from human activity.
2. Do not permit children to play on or around the stored machine.
3. Store the unit in a dry, level area. Support the frame with planks if required.



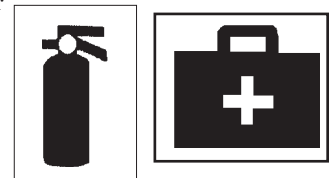
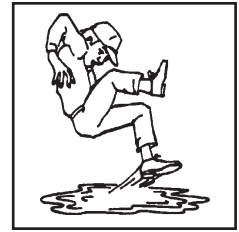

2.9 MAINTENANCE SAFETY

1. Good maintenance is your responsibility. Poor maintenance is an invitation to trouble.
2. Follow good shop practices.
 - Keep service area clean and dry.
 - Be sure electrical outlets and tools are properly grounded.
 - Use adequate light for the job at hand.
3. Make sure there is plenty of ventilation. Never operate the engine in a closed building. The exhaust fumes may cause asphyxiation.
4. Before working on this machine, shut off the engine, set the brakes, and remove the ignition key.
5. Never work under equipment unless it is blocked securely.
6. Use personal protection devices such as eye, hand, and hearing protectors, when performing any service or maintenance work.
7. Where replacement parts are necessary for periodic maintenance and servicing, genuine factory replacement parts **must** be used to restore your equipment to original specifications. The manufacturer will not be responsible for injuries or damages caused by use of unapproved parts and/or accessories.
8. A fire extinguisher and first aid kit should be kept readily accessible while performing maintenance on this equipment
9. Periodically tighten all bolts, nuts and screws and check that all cotter pins are properly installed to ensure unit is in a safe condition.
10. When completing a maintenance or service function, make sure all safety shields and devices are installed before placing unit in service.







3 SAFETY DECALS



The following safety decals should be attached to the equipment at all times. Should any decal become damaged or lost, it is the responsibility of the owner to replace it. Additional decals may be obtained from the manufacturer or Gearmore, Inc.

 WARNING	 ADVERTENCIA
	<p>Antes de probar la unidad por primera vez deben remitirse a las instrucciones contenidas en el manual.</p>
<p>Read and understand Owner Operator's Manual before operating unit.</p>	 ADVERTISSEMENT
	<p>S'assurer de bien comprendre toutes les consignes du manuel de propriétaire avant d'utiliser la unité.</p>

Part No: SD-010



 DANGER	 PELIGRO
	<p>CUCHILLAS ROTATIVAS</p> <ul style="list-style-type: none"> • Guarden las monas y los pies lejos de las cuchillas. • No se acerquen a la máquina estando funcionado el motor.
<ul style="list-style-type: none"> • Keep hands and feet away from blades. • Stay away from machine when engine running. 	 DANGER
	<p>LAMES ROTATIVES</p> <ul style="list-style-type: none"> • Garder les mains et les pieds éloignés des lames rotatives. • Rester loin de la machine quand le moteur tourne.

Part No: SD-012A

	 WARNING
	<p>Prepare for emergencies. Keep fire extinguisher and first aid kit available.</p>



WARNING! PREPARE FOR EMERGENCIES.

Keep fire extinguisher and first aid kit available.

	 WARNING
	<p>Check equipment before operation. Tighten all nuts and bolts.</p>

WARNING! CHECK EQUIPMENT BEFORE OPERATING.

Tighten all nuts and bolts before operating. Make certain that equipment is lowered to ground before attempting to make adjustments or perform maintenance.

	 DANGER
	<p>Rotating blades. Keep hands and feet away from blades.</p>

DANGER! STAY CLEAR OF ROTATING BLADES.

The harrow is designed to cut soil, turf, and ground litter. Keep hands and feet away from blades!

REMEMBER - If safety signs have been damaged, removed, become illegible or parts replaced without signs, new signs must be applied. New signs are available from your authorized dealer.

4 OPERATION

4.1 TO THE NEW OPERATOR OR OWNER



DANGER! KEEP RIDERS OFF MACHINE.

Riders can be seriously injured by entanglement or by falling.



WARNING! TRANSPORT WITH CARE.

Before transporting to a new location, make certain that the slow-moving vehicle emblem is installed and is clearly visible. Use flashing lights and follow local traffic regulations.

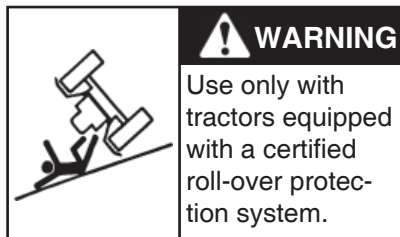

WARNING! ROLL-OVER PROTECTION.

Do not operate the harrow on any tractor not equipped with a certified roll-over protection system.

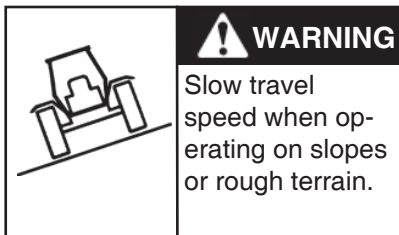

WARNING! SLOPES AND ROUGH TERRAIN.

When operating on slopes or rough terrain, slow travel speed. Do not operate in an area where the tractor could roll over. **Be sure to fasten safety belt when operating tractor!**



OPERATING SAFETY

1. Read and understand the Operator's Manual and all safety signs before operating, servicing, adjusting, repairing, or unplugging.
2. Do not allow riders.
3. Install and secure all guards and shields before starting or operating.
4. Keep hands, feet, hair, and clothing away from moving parts.
5. Place all controls in neutral, stop tractor engine, set park brake, remove ignition key and wait for all moving parts to stop before servicing, adjusting, repairing, or unplugging.
6. Place all tractor and machine controls in neutral before starting.
7. Never start or operate machine unless sitting on tractor seat.
8. Clear the area of bystanders, especially small children, before starting.
9. Clean reflectors, SMV and lights before transporting.
10. Use hazard flashers on tractor when transporting.
11. Do not put hands or feet under machine while tractor engine is running.
12. Review safety instructions with all operators annually.

4.2 MACHINE BREAK-IN

Although there are no operational restrictions on the Aerator when used for the first time, it is recommended that the following mechanical items be checked:

A. After Operating The First Day:

1. Check all nuts, bolts and other fasteners. Tighten to their specified torque level.
2. Check that the tines are in good condition.

4.3 PRE-OPERATION CHECKLIST

Efficient and safe operation of the Aerator requires that each operator reads and understands the operating procedures and all related safety precautions outlined in this section. A pre-operation checklist is provided for the operator. It is important for both the personal safety and maintaining the good mechanical condition of the Aerator that this checklist is followed.

Before operating the machine and each time thereafter, the following areas should be checked off:

- √ Use only a tractor of the correct horsepower rating on the machine.
- √ Check that the machine is properly attached to the tractor. Be sure retainers are used on the mounting pins.
- √ Be sure extra weights are mounted on the front of the tractor if required.
- √ Check the tines. Be sure they are not damaged or broken and are not badly worn. Repair or replace as required.
- √ Check for entangled material. Remove this material.

4.4 FIELD OPERATION



OPERATING SAFETY

1. Read and understand the Operator's Manual and all safety signs before operating, servicing, adjusting, repairing, or unplugging.
2. Do not allow riders.
3. Install and secure all guards and shields before starting or operating.
4. Keep hands, feet, hair, and clothing away from moving parts.
5. Place all controls in neutral, stop tractor engine, set park brake, remove ignition key and wait for all moving parts to stop before servicing, adjusting, repairing, or unplugging.
6. Place all tractor and machine controls in neutral before starting.
7. Never start or operate machine unless sitting on vehicle seat.
8. Clear the area of bystanders, especially small children, before starting.
9. Use hazard flashers on tractor when transporting.
10. Do not put hands or feet under machine while vehicle engine is running.

Each operator should review this section of the manual at the start of the season and as often as required to be familiar with the machine. When using, follow this procedure:

1. Review and follow the Pre-Operation Checklist.
2. Attach the vehicle to the machine.



CAUTION:

DO NOT make turns with the tines in the ground. Your Aerator must be lifted out of the ground when making turns to prevent non warranty damage to the Aerator.



DANGER:

Excessive vehicle speed or radical operation when turning can endanger tractor and operators safety.

OPERATING INSTRUCTIONS:

The SP Series of slicing aerators are available in pull type 3-point hitch.

1. Connection:

Pull Type Aerator -

Connect the pull type aerator to the towing vehicle. Adjust the turnbuckle on the aerator

so the tongue is level. Connect the electric wires to the vehicle's 12 volt battery. Then operate the electro hydraulic system so the blades clear the ground as much as possible. Drive to the area to be aerated and raise the gauge wheels so all the weight is on the blades.

3-Point Hitch Aerator -

If you purchased a 3-point hitch aerator, connect the aerator to the 3-point hitch of the tractor. Raise the 3-point hitch and drive to your work area. Lower the tractor 3-point hitch so all the weight is on the tines.

2. For best results, the maximum tine depth obtains the most effective aeration. If you can not obtain maximum depth, additional weight may be required. If the soil is severely compacted, it may be necessary to water several times in order to loosen the ground.
3. Travel at a speed which is safe, keeping in mind tractor stability, steering ability, soil and weather conditions, and operator comfort.
4. **DO NOT** make sharp turns with the tined roller in the ground. The Aerator tines must be lifted out of the ground when making sharp turns.
5. Severely compacted soil and high traffic areas may need to be aerated several times.

4.5 TRANSPORTING



TRANSPORT SAFETY

1. Make sure you are in compliance with all local regulations regarding transporting equipment on public roads and highways.
2. Do not allow anyone to ride on the Aerator or vehicle during transport.
3. Do not exceed 20 mph (32 kph). Reduce speed on rough roads and surfaces.
4. Use retainers on the mounting pins when attaching.
5. Always use hazard flashers on the tractor when transporting unless prohibited by law.

When transporting the machine, review and follow these instructions:

1. Be sure all bystanders are clear of the machine.
2. Be sure that the machine is securely attached to the tractor and all retainer pins are installed.
3. Be sure you have installed extra weights on the front of the tractor if required.
4. Be sure you are in compliance with all applicable lighting and marking regulations when transporting. Check with your local authorities.
5. Be sure your machine can clearly be seen by overtaking and oncoming traffic.
6. Keep to the right and yield the right-of-way to allow faster traffic to pass. Drive on the road shoulder if permitted by law.
7. Do not allow riders.
8. Always use hazard flashers on the vehicle when transporting unless prohibited by law.

4.6 STORAGE



STORAGE SAFETY

1. Store the unit in an area away from human activity.
2. Do not permit children to play on or around the stored machine.
3. Store the unit in a dry, level area. Support the frame with planks if required.

After the season's use, the machine should be thoroughly inspected and prepared for storage. Repair or replace any worn or damaged components to prevent any unnecessary down time at the start of next season. To insure a long, trouble free life, this procedure should be followed when preparing the unit for storage:

1. Clear the area of bystanders, especially small children.
2. Thoroughly wash the machine using a pressure washer to remove all dirt, mud, debris and residue.
3. Inspect the implement for damage or entangled material. Repair or replace damaged parts. Remove all entangled material.
4. Touch up all paint nicks and scratches to prevent rusting.
5. Move to storage area.
6. Select an area that is dry, level and free of debris.
7. Unhook from vehicle.
8. If the machine cannot be placed inside, cover with a waterproof tarpaulin and tie securely in place.
9. Store the machine in an area away from human activity.
10. Do not allow children to play on or around the stored machine.

5 GENERAL MAINTENANCE

5.1 TINES

1. Inspect tines for signs of excessive wear or breakage before operating the Aerator.
2. Re-torque tine bolts to **(120 ft./lbs)** after first day of use.
3. After first week of use, re-check torque to make sure the tines are locked tightly in place.

5.2 TINES REPLACEMENT:

If tines are badly worn or broken, replace them right away to ensure effective use of your Aerator. The turf aerators come standard with $\frac{3}{8}$ " sport tines. The farm aerators come standard with $\frac{1}{2}$ " ag tines.

5.3 BEARING MAINTENANCE AND LUBRICATION:

Lubricate bearings daily with water resistant, **lithium based, EP 2 grease** or equal. Use enough grease to purge contaminants out of the bearings. To improve the effectiveness of the lubrication process, rotate the rotors by hand to ensure that the fresh grease is evenly distributed throughout the bearing and purge out contaminated grease. Continue until the fresh grease is visible.



CAUTION:

Be careful not to allow hands and clothes to become entangled in the sharp rotating tines.

5.4 BOLT TORQUE

CHECKING BOLT TORQUE

The tables shown below give correct torque values for various bolts and capscrews. Tighten all bolts to the torques specified in chart unless otherwise noted. Check tightness of bolts periodically, using bolt torque chart as a guide. Replace hardware with the same strength bolt.

ENGLISH TORQUE SPECIFICATIONS

Bolt Diameter "A"	Bolt Torque *					
	SAE 2		SAE 5		SAE 8	
	N.m	(lb-ft)	N.m	(lb-ft)	N.m	(lb-ft)
1/4"	8	(6)	12	(9)	17	(12)
5/16"	13	(10)	25	(19)	36	(27)
3/8"	27	(20)	45	(33)	63	(45)
7/16"	41	(30)	72	(53)	100	(75)
1/2"	61	(45)	110	(80)	155	(115)
9/16"	95	(70)	155	(115)	220	(165)
5/8"	128	(95)	215	(160)	305	(220)
3/4"	225	(165)	390	(290)	540	(400)
7/8"	230	(170)	570	(420)	880	(650)
1"	345	(225)	850	(630)	1320	(970)

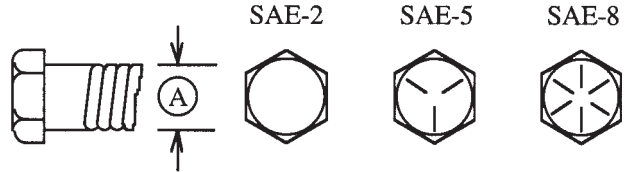

Torque figures indicated above are valid for non-greased or non-oiled threads and heads unless otherwise specified. Therefore, do not grease or oil bolts or capscrews unless otherwise specified in this manual. When using locking elements, increase torque values by 5%.

* Torque value for bolts and capscrews are identified by their head markings.

6 REPLACEMENT PARTS

6.1 BEARINGS AND TINES

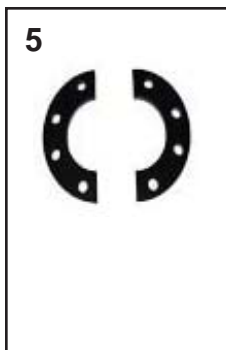
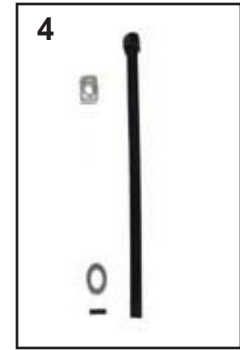

<u>REF #</u>	<u>PART NO.</u>	<u>DESCRIPTION</u>
1	225-0066	Bearing, Axle - 4 Hole Flange
2	225-0152	Bearing, Takeup
3	226-0040	Frame, Takeup Bearing Mount
4	226-0079	Bolt Assembly, Takeup
5	226-0169	Ring, Tine Mounting, Half (2 Required)
6	226-0047	Tine, Turf - ¼"
7	226-0046	Tine, Turf - ½"
	226-0043	Tine, Turf - ½"
8	226-9999	Tine, Spikxx Ag

6.2 MISCELLANEOUS PARTS

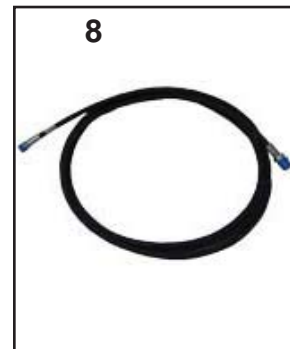
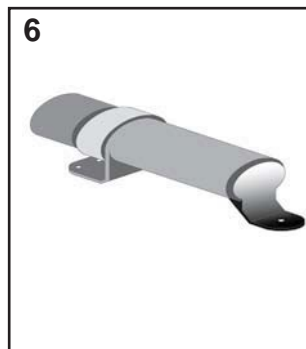
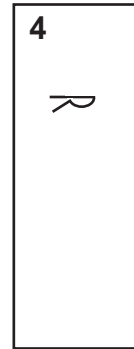
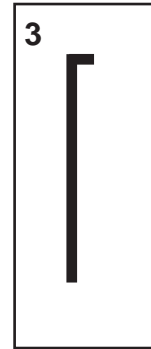

<u>REF #</u>	<u>PART NO.</u>	<u>DESCRIPTION</u>
1	126-040	Tank, Water Weight, 50 Gallon with Drain Kit
2	BM-01	Strap, Ratchet Tie Down (Set of 2)
3	700-226-0031	Bar, Tank Rack
4	225-0065	Clip, Hair #6
5	226-0222	Stand, parking w/Locking Pin
6	MH-01	Manual, Holder
7	255-400	Cylinder, Hydraulic - 1 1/2" x 6"
8	226-0076	Hose Kit (Hydraulic)

6.3 FRAME & BRUSH ASSEMBLY

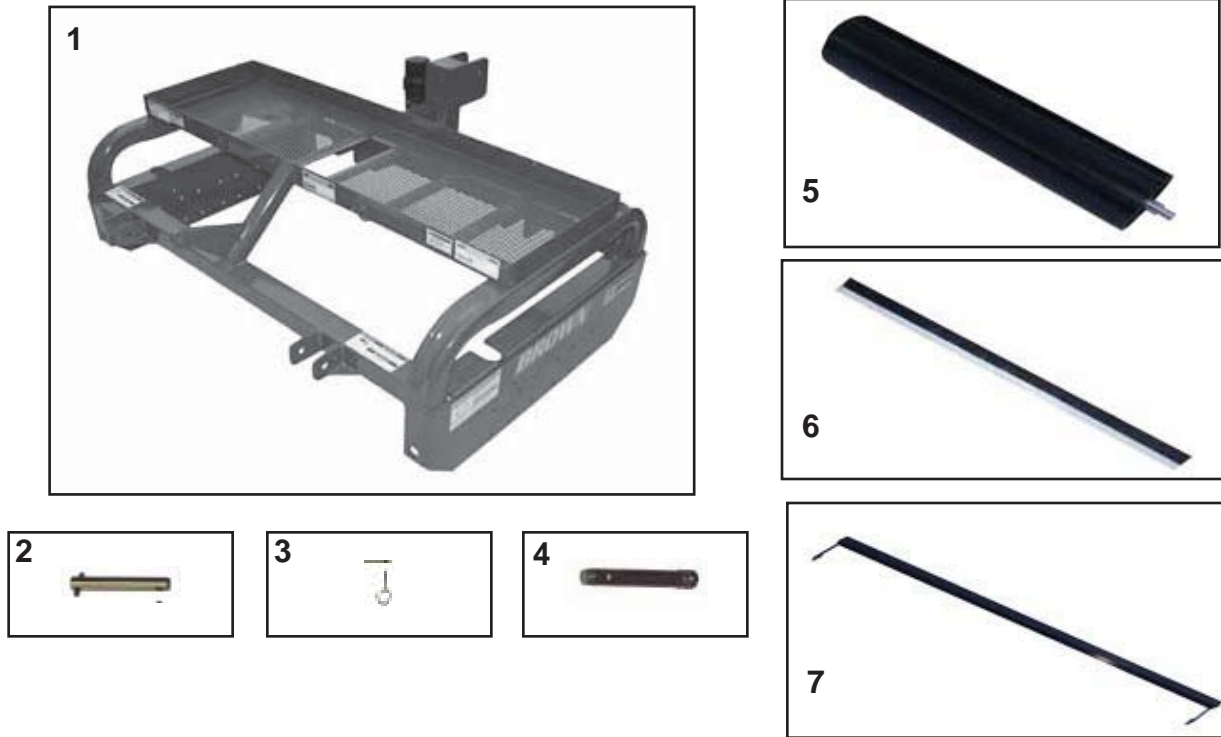

<u>REF #</u>	<u>PART NO.</u>	<u>DESCRIPTION</u>
1	226-0200	Frame, SP-72, Painted w/Decals
1	226-0010	Frame, SP-60, Painted w/Decals
1	226-0152	Frame, SP-48, Painted w/Decals
1	226-0151	Frame, SP-36, Painted w/Decals
2		Pin, Top Link, Cat. 1
3		Pin, Lynch
4		Pin, Lift, Cat. 1
5	226-0215	Roller, Press - SP-72
5	226-0037	Roller, Press - SP-60
5	226-0155	Roller, Press - SP-48
5	226-0165	Roller, Press - SP-36
6		Brush w/ Track SP-72
6	226-0189	Brush w/Track SP-60
6	226-0184	Brush w/Track SP-48
6	226-0181	Brush w/Track SP-36
Not Shown	No Part No.	Brush Mounting Bolts - 1/4" x 1" w/Lock Washer & Nut
7		Bracket, Mounting, Brush SP-72
7	226-0090	Bracket, Mounting, Brush SP-60
7	226-0153	Bracket, Mounting, Brush SP-48
7	226-0168	Bracket, Mounting, Brush SP-36
Not Shown	No Part No.	Bracket Mounting Bolts - 3/8" x 1 1/2" w/Lock Washer & Nut

6.4 REPLACEMENT AXLE



<u>REF #</u>	<u>PART NO.</u>	<u>DESCRIPTION</u>
1	226-0206	Axle Assembly SP-72 - 7" Spacing w/Turf Tines
1	226-0208	Axle Assembly SP-72 - 7" Spacing
1	226-0209	Axle Assembly SP-72 - 5" Spacing w/Turf Tines
1	226-0205	Axle Assembly SP-72 - 5" Spacing
1	226-0210	Axle Assembly SP-72 - 7" Spacing w/Ag Tines
1	226-0217	Axle Assembly SP-72 - 4" Spacing w/Turf Tines (2 required)
1	226-0216	Axle Assembly SP-72 - 4" Spacing (2 required)
1	226-0044	Axle Assembly SP-60 - 7" Spacing w/Turf Tines
1	226-0045	Axle Assembly SP-60 - 7" Spacing
1	226-0041	Axle Assembly SP-60 - 5" Spacing w/Turf Tines
1	226-0042	Axle Assembly SP-60 - 5" Spacing
1	226-0100	Axle Assembly SP-60 - 7" Spacing w/Ag Tines
1	226-0175	Axle Assembly SP-60 - 4" Spacing w/Turf Tines (2 required)
1	226-0176	Axle Assembly SP-60 - 4" Spacing (2 required)
1	226-0157	Axle Assembly SP-48 - 7" Spacing w/Turf Tines
1	226-0156	Axle Assembly SP-48 - 7" Spacing
1	226-0110	Axle Assembly SP-48 - 5" Spacing w/Turf Tines
1	226-0154	Axle Assembly SP-48 - 5" Spacing
1	226-0158	Axle Assembly SP-48 - 7" Spacing w/Ag Tines
1	226-0170	Axle Assembly SP-48 - 4" Spacing w/Turf Tines (2 required)
1	226-0171	Axle Assembly SP-48 - 4" Spacing (2 required)
1	226-0161	Axle Assembly SP-36 - 7" Spacing w/Turf Tines
1	226-0160	Axle Assembly SP-36 - 7" Spacing
1	226-0164	Axle Assembly SP-36 - 5" Spacing w/Turf Tines
1	226-0163	Axle Assembly SP-36 - 5" Spacing
1	226-0162	Axle Assembly SP-36 - 7" Spacing w/Ag Tines
1	226-0166	Axle Assembly SP-36 - 4" Spacing w/Turf Tines (2 required)
1	226-0167	Axle Assembly SP-36 - 4" Spacing (2 required)

6.5 REPLACEMENT PARTS

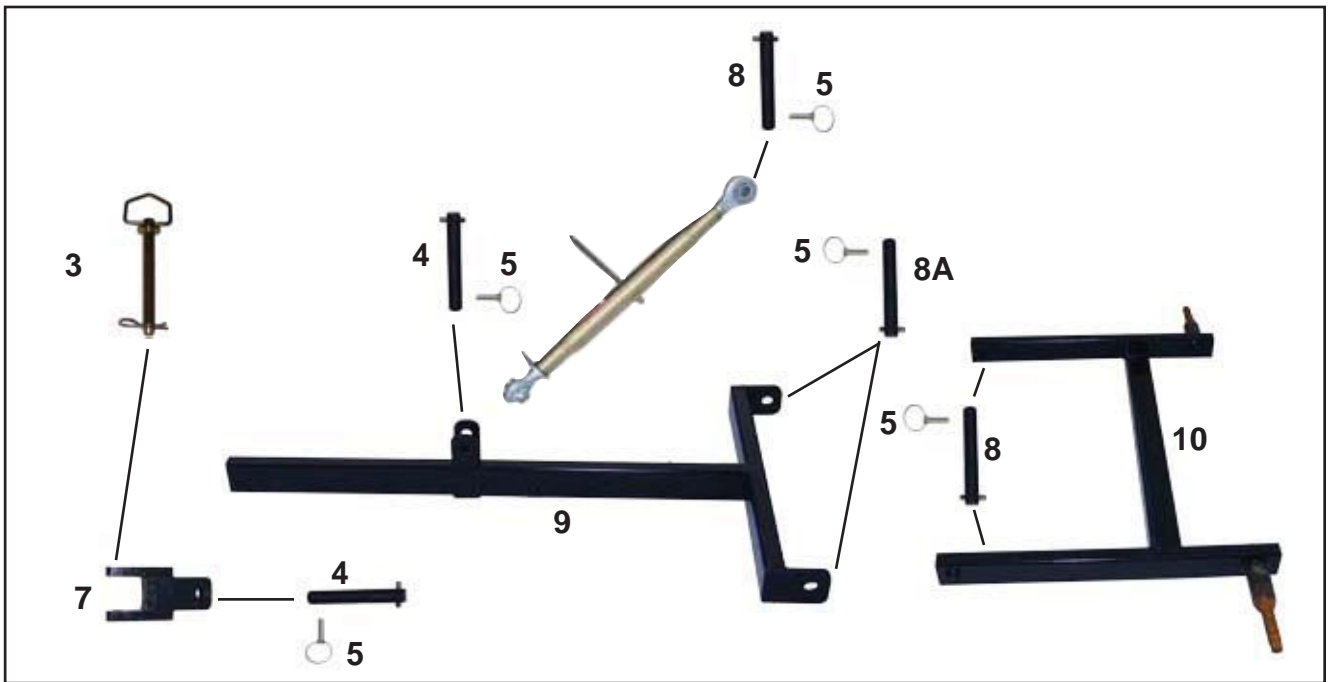

6.5 REPLACEMENT PARTS (Continued)

<u>REF #</u>	<u>PART NO.</u>	<u>DESCRIPTION</u>
1	225-0051	Light, Kit w/Wiring Harness and SMV Decal
2	225-0046	Jack, Tongue
3	UT-207A	Pin, Pull 1" w/Hair Clip
4	255-010	Pin., 3/4"
5	TC-126A	Pin, Lynch
6	255-0014	Turnbuckle, Top Link, Cat. 1
7	226-0030	Clevis, Hitch
8	500-21	Pin, Top Link, Cat. 1
8A	255-005	Pin, Lift, 7/8" Cat. 1
9	226-0031	Tongue, Transport
10	226-0033	Carrier, Off Road
10	226-0065	Carrier, On Road
11	UT-123OB	Bearing, Outer
12	UT-120IB	Bearing Inner
13	UT-122S	Seal
14	65-C	Cup, Outer
15	UT-121IC	Cup, Inner
16	UT-130	Cap, Dust
17	UT-119HA	Hub, Assembly Complete - Bearings, Cups, Seal & Dust Cap
18	226-0034	Tire & Wheel - Off Road ONLY
19	UT-114	Wheel - On Road
20	226-0230	Tire - On Road

7 LIMITED WARRANTY



GEARMORE, INC., warrants each new Gearmore product to be free from defects in material and workmanship for a period of twelve (12) months from date of purchase to the original purchaser. This warranty shall not apply to implements or parts that have been subject to misuse, negligence, accident, or that have been altered in any way.

Our obligation shall be limited to repairing or replacement of any part, provided that such part is returned within thirty (30) days from date of failure to Gearmore through the dealer from whom the purchase was made, transportation charges prepaid.

This warranty shall not be interpreted to render us liable for injury or damages of any kind or nature, direct, consequential or contingent, to person or property. This warranty does not extend to loss of crops, loss because of delay in harvesting or any other expenses, for any other reasons.

Gearmore in no way warrants engines, tires, or other trade accessories, since these items are warranted separately by these respective manufacturers.

Gearmore reserves the right to make improvements in design or changes in specification at any time, without incurring any obligations to owners or units previously sold.

Please be advised that all warranty work done by your dealer must be approved by Gearmore before work begins.

GEARMORE, INC.
13477 Benson Ave.
Chino, CA 91710

Always refer to and heed machine operating warning decals on machine.